

***Snap-on***® **Tools**

# WORK WITH QUALITY

---

## Q3 QUARTERLY PROMOTION

**Bullingens Maskin & Verktyg**  
**070-797 60 00**  
**stefan.fossum@gmail.com**

Kampanjen gäller t.o.m. 30 sep 2022,  
med reservation för ev. slutförsäljning.  
Alla priser exkl. moms.



# 1/2" 18V



# 1/2" AIR

**S** 8995:-

**S** 3495:-



GUN METAL



**18V 1/2" IMPACT WRENCH**  
22Q3-CTU9080GM

- 1,952Nm of Bolt Breakaway Torque
- kit includes CT9080DB body, (2) CTB8187 batteries and (1) charger CTCEU131



RED



**1/2" HEAVY-DUTY AIR IMPACT WRENCH** | 22Q3-MG725A

- 1,613 Nm bolt breakaway torque and 1,098 Nm working torque
- Faster motor start-up and greater performance with more torque than previous model

## BRINGING YOU POWER

**3 PC QUICK-CHANGE ADAPTOR SET** | 22Q3-QC3ALC

**S** 475:-

- High-quality steel for a long life
- Tight tolerances for less chance of stripping or cam-out
- Quick-release chuck with knurled sleeve for fast easy bit changes
- Suitable for 3/8 and 1/2" drive impact wrenches



**STANDARD/ TWIST WHEEL FLIP SOCKET SET** | 22Q3-LSR1500



- (6) sockets for use on lug nut sizes: 3/4, 13/16, and 7/8", and 17, 19, and 21 mm
- 6-point Flank Drive® wrenching system at one end and a six-fluted twist socket for removal of damaged wheel lugs at the other end
- Socket flips when encountering a damaged head
- All 1/2" drive for use with hand drivers or impact wrenches
- Black oxide finish

Blue-Point

**S** 1500:-



# MAKE AN IMPACT

## 3/8" DRIVE LOCK BUTTON SWIVEL BALL IMPACT UNIVERSAL JOINT | 22Q3-IPF80B



**5** 350:-

- Black oxide finish
- Designed to absorb repeated impact cycling
- Heat-treated to a lower hardness adds impact resistance and toughness, which allows a longer universal joint life

## 2 PC 3/8" DRIVE IMPACT SWIVEL EXTENSION SET (6 AND 9") | 22Q3-202IPFX



**5** 1200:-

- For fasteners on a "hard to reach" angle
- Laser welded pivot pin for smooth, full 30° swivel action for efficient power transfer
- Includes IPFX6 and IPFX9 (6 and 9")

## 12 PC 3/8" DRIVE 6-POINT METRIC FLANK DRIVE® SEMI-DEEP IMPACT SOCKET SET (8-19 MM) | 22Q3-212IMFMSYA



**5** 1225:-

- Includes IMFMS8A-IMFMS19 (8-19 mm) in a plastic storage tray

## 9 PC 3/8" DRIVE METRIC SHALLOW TWIST IMPACT SOCKET SET | 22Q3-209TFMSYA



*Blue-Point*

**5** 1575:-

- (10-17 mm and 19 mm)
- Can be used with impact wrench
- Remove rounded or damaged fasteners with almost any head configuration (hex, round, square and more)
- Manufactured from heat treated alloy steel
- Black industrial finish



**15PC 1/2" GPT DEEP METRIC FLANK DRIVE© IMPACT SOCKET SET (10-24MM) | 22Q3-315SIMMYA**



**5 3100:-**

**15PC 1/2" GPT SHALLOW METRIC FLANK DRIVE© IMPACT SOCKET SET (10-24MM) | 22Q3-315IMMYA**

**5 1750:-**



**1/4" DRIVE DUAL 80® TECHNOLOGY MAGNETIC BIT RATCHET | 22Q3-TM72**

**1/4"**



**5 650:-**

- Ideal for accessing fasteners in tight areas
- Dual 80® Technology based ratchet design features 72-tooth gear, with six teeth in contact with gear to provide strength and durability
- 25% less ratcheting arc than closest competitor and requires the least amount of arc to engage the next gear tooth
- Sealed head keeps lubricants in and contaminants out for longer life

**MAGNETIC RATCHET AND BIT SET | 22Q3-TM72SET**

- TM72 included
- Ratchet features magnetic retention for 1/4" hex bits
- Includes: SDM211B flat tip bit, SDM213B (9/32) flat tip bit, SDM2221IRB (#1) PHILLIPS® ACR® bit, SDM222IRB (#2) PHILLIPS® ACR® bit, SDMT15D (T15) TORX® bit



**5 800:-**



## 1/4" DRIVE STANDARD HANDLE EXTRA-LONG FLEXIBLE DRIVER | 22Q3-TM615



**S** 400:-

- Designed for carburetor work
- 1/4" drive at the end of a tough but flexible spring steel shank
- Ideal to access hard-to-reach adjusting screws
- Intended for low-torque applications

## 5 PC TORX® STUBBY UNIVERSAL BIT SOCKET SET (T20-T40) | 22Q3-105TUTX

- Numerous other applications for Mercedes-Benz® that require a TORX® Stubby Bit Socket where a TORX® Regular Bit Socket will not fit in T20, T25 and T27
- Includes (5) TORX® Stubby Universal Bit Sockets (T20, T25, T27, T30 and T40)
- Includes storage tray



**S** 1675:-

## 10 PC COMBINATION DRIVE TORX® BIT LONG SOCKET SET (T8-T50) | 22Q3-210EFTXL



- Includes 1/4" drive TTXL8E-TTXL25E (T8-T25) and 3/8" drive FTXL27E-FTXL50E (T27-T50) in a storage tray

**S** 2725:-

## 9 PC 1/4" DRIVE 6-POINT METRIC FLANK DRIVE® EXTRA-DEEP SOCKET SET | 22Q3-109STMML

- Newly designed 4-1/2" long extra-deep sockets with 4" bolt clearance
- Access to hard-to-reach or very tight areas



**S** 2250:-



**31 PC 1/4" DRIVE 6-POINT METRIC  
SHALLOW GENERAL SERVICE SOCKET SET**

22Q3-131TMPB

- Includes 6-point shallow sockets
- Includes (31 pc) 6-point deep sockets (5-15 mm)
- Includes 6" knurled extension, magnetic ratcheting screwdriver, 2" knurled extension, high-strength standard ratchet, breaker bar, universal joint, hex-to-square adaptor
- Includes storage case

**5** 4200:-

**GREAT DEALS!**

**11 PC 1/4" DRIVE METRIC 12-POINT FLANK DRIVE® SHALLOW SOCKET SET  
(5-14 MM)** | 22Q3-111TMMDY



**5** 1015:-

**10 PC 1/4" DRIVE 6-POINT SAE FLANK DRIVE® XTRA SHALLOW SOCKET SET**  
22Q3-110YTMY | (3/16-9/16")

**5** 1025:-





**11 PC 1/4" DRIVE 12-POINT METRIC FLANK DRIVE® DEEP SOCKET SET  
(5-14 MM) | 22Q3-111STMMDY**



**5 1650:-**

**10 PC 1/4" DRIVE 6-POINT SAE FLANK DRIVE® XTRA DEEP SOCKET SET  
22Q3-110YSTMY | (3/16-9/16")**

**5 1525:-**



**8 PC 1/4" DRIVE ESSENTIAL 10 MM SOCKET SET | 22Q3-108ES10MMY**



- Includes: TMM10, STMM10, YTMMS10, TMUSM10A, SIMTMM10, IMTMM1, TMMD10, and IPTMM10A in a storage tray

**5 1325:-**

**3/8"**

**7 PC 3/8" DRIVE 6-POINT METRIC LOW-PROFILE SOCKET SET | 22Q3-207FHRM**

- Includes (7) low-profile sockets (7, 8, 10, 12, 13, 14 and 17 mm)



**5 1050:-**

**12 PC 3/8" DRIVE 6-POINT METRIC FLANK DRIVE® XTRA DEEP SOCKET SET (8-19 MM)**

22Q3-212YSFSMY |



**S** 2475:-

**14 PC 3/8" DRIVE 6-POINT SAE FLANK DRIVE® XTRA DEEP SOCKET SET**

(1/8-1") | 22Q3-214YSFSY

**S** 2925:-



**8 PC 3/8" DRIVE ESSENTIAL 10 MM SOCKET SET | 22Q3-208ES10MMY**

- Manufactured from the highest quality proprietary steel, providing optimum strength and durability



**S** 1725:-

**3/8" DRIVE 12-POINT METRIC 14 MM FLANK DRIVE® STANDARD SPARK PLUG SOCKET | 22Q3-S9714MK**

- Spark plug extends through the socket for access in tight quarters
- Delivers 15-25% more turning power
- Rubber insert for secure retention of spark plug
- Manufactured from the highest quality proprietary steel, providing optimum strength and durability



**S** 300:-

**6 PC 3/8" DRIVE METRIC LONG BALL HEX BIT SOCKET SET (4-10 MM) | 22Q3-206EFABLM**

- Includes FABLM4E-FABLM10E (4-10 mm) in a plastic storage tray
- Extra-long bit length provides increased reach in limited-access spaces
- Ball-end of bit makes it easier to insert bit into fastener, especially in blind access application



**S** 1325:-





**3/8" DRIVE DUAL 80® TECHNOLOGY SOFT GRIP STANDARD HANDLE QUICK-RELEASE RATCHET | 22Q3-FHR80/G/O**

- 80-tooth gear for 4.5° of swing arc
- 7 teeth in contact with gear to provide strength and durability
- Quick-release has a positive locking feature to hold socket securely in place when needed and push button for easy removal
- Contoured handle for comfort and control



**5** 995:-

**3/8" DRIVE DUAL 80® TECHNOLOGY SOFT GRIP LONG HANDLE QUICK-RELEASE FLEX-HEAD RATCHET | 22Q3-FHRLF80A**

- Dual 80® Technology Ratchet Features: 80-tooth gear with seven teeth in contact with gear to provide strength and durability
- 25% less ratcheting arc than our closest competitor and requires the least amount of arc to engage the next gear tooth
- Quick-release has a positive locking feature to hold socket securely in place when needed and push button for easy removal



**5** 1090:-

- Round head is compact to get in tight quarters
- 100 teeth head design provides lower swing arc which means shorter movement before next tooth is engaged

**3/8" DRIVE 100-TOOTH ROUND HEAD RATCHET | 22Q3-FN100**

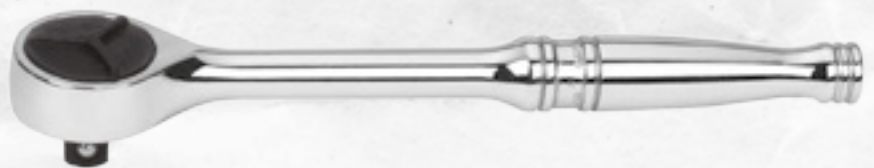

**5** 795:-

**6 PC 3/8" DRIVE WOBBLE PLUS EXTENSION SET (1-1/2-11") | 22Q3-206AFXWP**

- Set contains (6) wobble plus extensions, 1-1/2, 3, 4, 6, 8 and 11" in storage tray
- Wobble function provides 16° of additional accessibility
- Extensions are usable in both wobble and rigid functionality

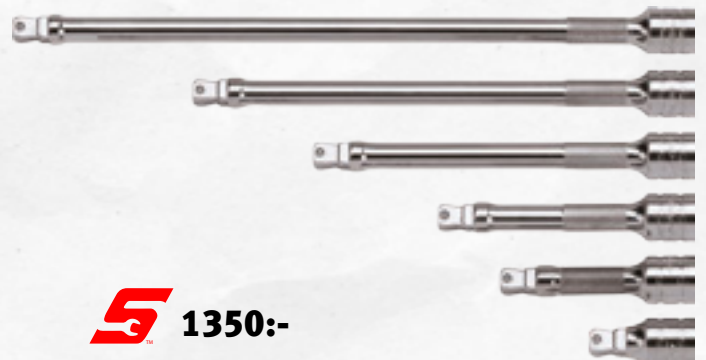

**5** 1350:-





**S** 1925:-

## PICK A COLOUR

1/2" 24" HARD GRIP HANDLE BREAKER  
BAR | 22Q3-SHBBD24R / G / PB / O / HV

**S** 1225:-



1/2" DUAL 80® STANDARD HARD GRIP LOCKING FLEX-HEAD  
RATCHET | 22Q3-SHXD80BR

- Flex-head design allows exceptional versatility, with multiple locking positions for convenient access to work
- Dual 80® Technology ratchet design features 80-tooth gear, with seven teeth in contact with gear to provide strength and durability

**S** 1950:-



**S**  
RED

# ESSENTIAL TOOLING

## 4 MM METRIC T-SHAPED HEX WRENCH | 22Q3-AWMCG1604B



**S** 45:-



## 10 PC METRIC FOLDING HEX KEY SET (1.5-10 MM) | 22Q3-AWMEF10K

- Tri-fold design allows for up to five additional keys in the set, without increased size of housing
- Impact-modified nylon housing designed to minimize loss of torque transfer to hex keys and prevent damage if dropped
- Gold-finish plating provide superior corrosion protection to traditional coating methods



**S** 225:-



## 16 PC 3/8" DRIVE METRIC OPEN-END CROWFOOT WRENCH SET (9-24 MM)

| 22Q3-216FCOM

**S** 3775:-



## 10 MM 12-POINT METRIC FLANK DRIVE® FLEX HEAD/ OPEN-END COMBINATION WRENCH

| 22Q3-FHOM10B



**S** 425:-

## 6 MM 12-POINT METRIC 15° OFFSET RATCHETING COMBINATION WRENCH

| 22Q3-BOERM6

**S** 150:-

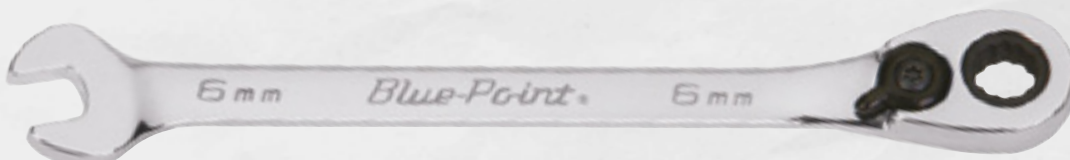

## 7 MM 12-POINT METRIC 15° OFFSET RATCHETING COMBINATION WRENCH

| 22Q3-BOERM7

**S** 150:-

*Blue-Point*





**4 PC 12-POINT METRIC 15° OFFSET RATCHETING COMBINATION WRENCH SET (21-25) | 22Q3-BOERM704**

- Includes (4 pc) (21 mm, 22 mm, 24 mm and 25 mm)
- Includes storage tray

**5 1350:-**

**10 PC 12-POINT METRIC FLANK DRIVE® COMBINATION WRENCH SET (10-19 MM) | 22Q3-OEXM710B**

- Includes OEXM100B-OEXM190B (10-19 mm) in a storage tray
- 7.5° offset broaching allows the user to flip the box end over to obtain a more advantageous grip on a fastener for restricted clearance areas
- A continuous arc design distributes stress over the entire wrench opening radius for greater strength
- Longer handles provide increased leverage and greater access to those hard to reach areas



**5 2750:-**



**7 PC 6-POINT METRIC FLANK DRIVE® COMBINATION WRENCH SET (10-15 AND 17 MM) | 22Q3-OSHM707B**

- Includes OSHM100B-OSHM150B and OSHM170B (10-15 and 17 mm) in a storage tray
- The Flank Drive® system grips the fastener flats and provides up to 15-20% more turning power

**5 1825:-**

**7 PC 6-POINT METRIC FLANK DRIVE® MIDGET COMBINATION WRENCH SET (4-9 MM) | 22Q3-OXIM707SBK**

- Includes (7) midget combination wrenches (4-9 mm)
- Includes kit bag

**5 1450:-**



# GRAB YOURSELF A DEAL.



**7" WIRE STRIPPER/ CUTTER/ CRIMPER (14-24 AWG) | 22Q3-PWCSS7ACF**

- Strong, serrated gripping nose for bending, pulling and shaping of wire or connectors
- Precision-ground stripping holes
- Wire cutter in two places: in jaws and near the handle
- Wire crimper placed in front of the pivot point for crimping in tight spaces

**5 375:-**



**3 PC PLIERS SET | 22Q3-PL307ACFO**

- VectorEdge Cutters provide power and finesse at all points on the cutting edges
- Features a riveted, three-position slip joint with diamond-serrated jaws for maximum versatility and increased gripping capability
- Set includes (1) diagonal cutter (87ACF), (1) needle nose plier (97ACF) and (1) slip joint plier (47ACF)

**5 1100:-**



**USE 22Q3-PL330ACFPWC | PL330ACF & PWCS9CF**

- 3 pc set includes 49ACF, 312CF and 911ACF

**5 1850:-**



**USE 22Q3-PL330ACFGPWC | PL330ACFG & PWCS9CFG**

- 3 pc set includes 49ACFG, 312CFG and 911ACFG

**5 1875:-**





USE 22Q3-PLWIRESGLG | BUY PLWIREKITG GET SGLASA204CG

**5** 1800:-

## BUY



### 3 PC WIRE SERVICE PLIERS SET

- Includes 786CFG, 29ACFG and PWCS7ACFG

## GET

### 4 PC INSTINCT® SOFT GRIP LONG PICK SET

- Use for scribing, alignment, O-ring removal, piercing holes in leather or fabric and cleaning nooks and crannies

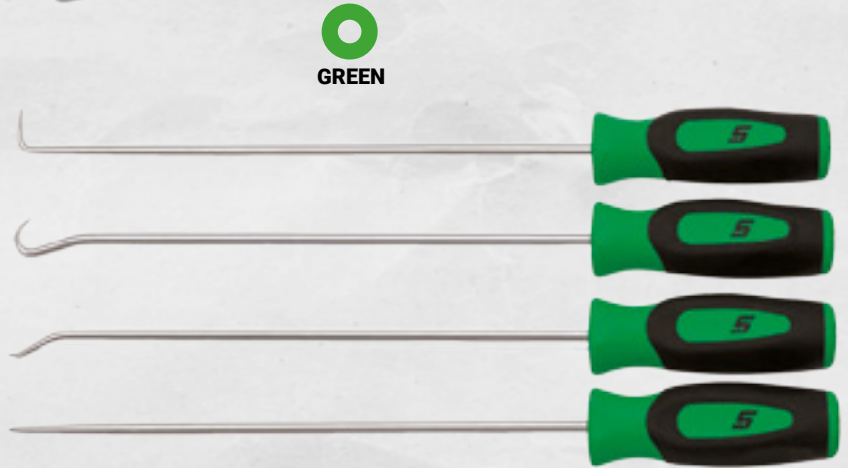

# PICK THE RIGHT TOOL.

### RADIATOR HOSE PICK SET | 22Q3-SGA102BG / O

**5** 525:-



GREEN



ORANGE



### 2 PC SOFT GRIP RADIATOR HOSE PICK SET | 22Q3-SGRHT2BG / O

**5** 425:-



GREEN



ORANGE



- Quickly removes radiator hoses from clamps
- Also good for pulling cotter pins



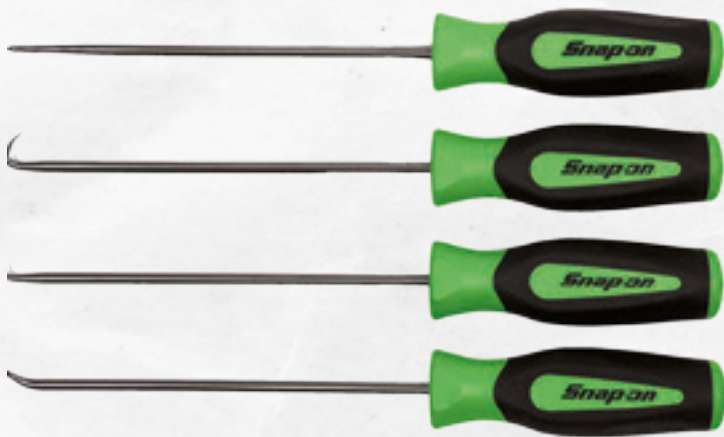

**4 PC INSTINCT® HEAVY-DUTY PICK SET** | 22Q3-SGLASA604BG / R

**5** 525:-



- Makes scribing, aligning, O-ring removal, piercing holes in leather or fabric and cleaning recessed areas easier
- 6" exposed pick length

**4 PC MINI ACETATE HANDLE PICK SET**

| 22Q3-ASA204BR

- Classic SDD series handles offer unique blend of durability, comfort and easy cleanup
- Contour thumb stop helps user apply maximum pressure



**5** 450:-



**4 PC INSTINCT® LONG HD PICK SET**

| 22Q3-SGLASH1204BR

**5** 575:-

- Heavy-duty 3/16" dia. alloy pick material
- Exclusive 45° tip geometry for pulling wires or components in tight areas; requires less angle than traditional "C" hooks
- Popular tips (90° "L" and 45° "V") in both 6 and 12" lengths

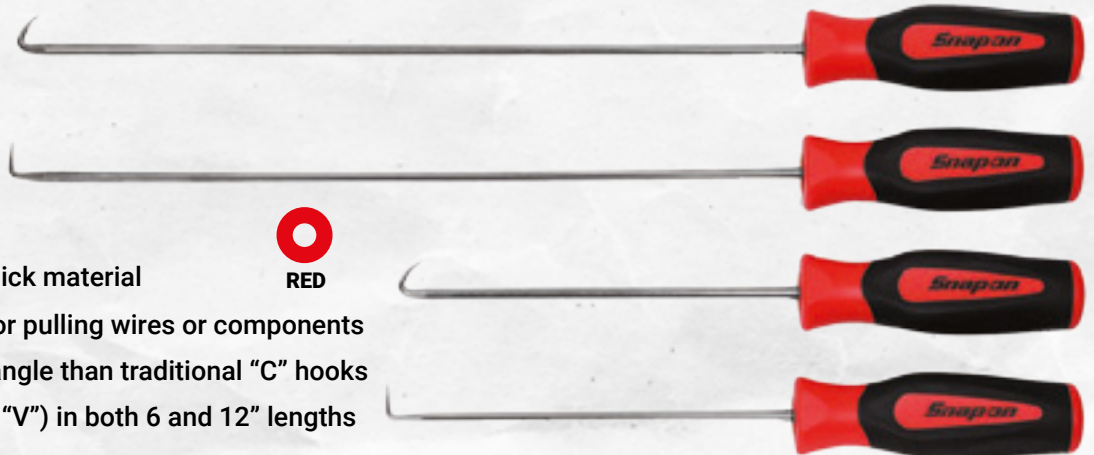

**2 PC INSTINCT® EXTRA-LONG RADIATOR HOSE PICK SET** | 22Q3-SGAL102BR

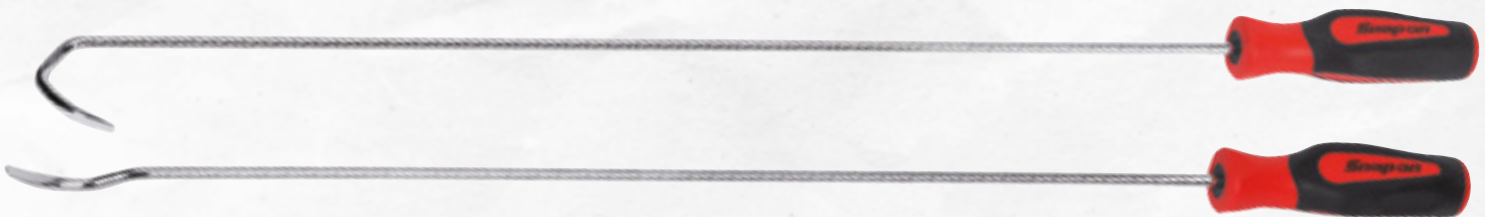

- 26" long tools remove radiator hoses from hard to reach clamps and fittings
- Thin wide blade style significantly reduces the chance of puncturing/damaging hoses
- Bent blade faces back towards handle so the hose can be "pulled" off
- Straight blade pushes away from handle so the hose would be "pushed" off

**5** 875:-

# HAMMER TIME!

## 24-OUNCE PLASTIC TIP HAMMER

22Q3-HBPT24



RED

**5** 495:-

- Plastic-tip for use where metal-to-metal scratching or marring should be avoided
- Tip surface yields when an object is struck
- Ribbed, textured grip with energy absorbing microcellular material enhances comfort and reduces vibration

## 40 OZ BALL PEEN SOFT GRIP DEAD BLOW HAMMER

22Q3-HBBD40HV

**5** 925:-



HI-VIZ

- Polished steel peen and head for smooth striking surface
- Composite shank extends from the head through handle, delivering a more powerful blow and dampening vibration
- Internal steel canister with free-flowing shot design delivers maximum dead blow action



## 5 PC FLAT CHISEL SET

22Q3-PPC50AK

**5** 1275:-

- 5 pc in KB2173 kit bag

## 9" FLAT CHISEL

22Q3-PPC832B

**5** 475:-

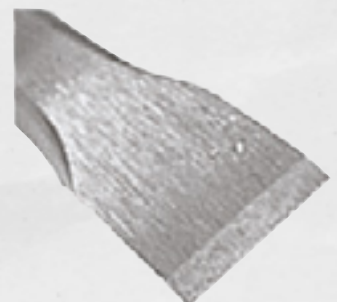



### 5 PC PHILLIPS® INSTINCT® DIAMOND TIP SOFT GRIP SCREWDRIVER SET

22Q3-SGDDP50BR

**5** 975:-



- Set contains SGDDP31RBR–SGDDP63RBR (5 pc) (#1, #2, #1, #2, #3) in storage tray
- Diamond particles "bite" into fasteners which minimizes slipping



### 7 PC TORX® INSTINCT® SOFT GRIP LONG TAMPER-RESISTANT SCREWDRIVER SET

22Q3-SGDTRXL70BR

**5** 1450:-

- Includes (7 pc) (T8, T10, T15, T20, T25, T27 and T30)
- Includes storage tray



### 7 PC TORX® HARD HANDLE SCREWDRIVER SET | 22Q3-SDDTX70AG

**5** 1200:-

- Designed for internal type TORX® fasteners used in the automotive and appliance industries





**2 PC EXTRA-LONG SCREWDRIVER SET**

22Q3-SGDXXL20BR

**5** 650:-



- Set contains SGD424BR Flat Tip Screwdriver and SGDP242BR PHILLIPS® Screwdriver (2 pc) in storage tray



**T-HANDLE RATCHETING MAGNETIC STANDARD SCREWDRIVER**

22Q3-SSDMRT4R

**5** 450:-

- Includes SDM2221RB #2 PHILLIPS® ACR® bit

**12" PRYBAR** | 22Q3-1250

**5** 350:-



**16" PRYBAR** | 22Q3-1650

**5** 500:-



**36" PRYBAR** | 22Q3-SPBS36AG



**5** 975:-

**USE 22Q3-PBSPBN | BUY BS704 & GET PBN500**

**5** 2525:-

**BUY**

**4 PC PRYBAR SET** | PBS704

**GET**

**5 PC NON-MARRING PRYBAR SET** | PBN500



# FILING ESSENTIALS

## 4PC MIXED FILE SET SOFT GRIP | 22Q3-SGHBF500A/G/ O

**5** 1100:-

- Includes 1 triple square file, 2 mill files and 1 round file in a nylon pouch
- Popular file shapes and profiles used for general filing and deburring applications



## 4PC INSTINCT® SOFT GRIP HANDLE ROUND FILE SET | 22Q3-SGHBF200A

**5** 1150:-

- 6"x5.5mm
- 8"x7mm
- 10"x9.5mm
- 12"x12.7mm



## FACE SHIELD | 22Q3-GA225A



- Impact-resistant polycarbonate shield
- Aspherical lens design provides larger area of face protection

**5** 250:-

## BLUE-POINT® EAR PROTECTORS | 22Q3-GA3200



- 28dB noise reduction rating
- Lightweight and comfortable with cushioned head band

**5** 225:-

*Blue-Point*

# WORK SAFE. WORK SMART.



# CUT TO PERFECTION



**BI-MOLD SOFT GRIP HANDLE HACKSAW | 22Q3-HSG319 / O**

**5 350:-**



RED

**5 350:-**



ORANGE

- Solid steel frame overmolded with soft grip for comfortable use
- Designed for 12" (300mm) blades

## 4 PC LONG-NECK CARBIDE BURR SET | 22Q3-VWBL400

- Grinding burrs are ideal for use with Snap-on® die grinders
- 1/4" and 1/8" shank burrs are available, all with solid carbide heads
- 1/8" shank units all have a maximum head diameter of 1/8"

**5 1725:-**



ORANGE

## 3 PC TRIM PAD REMOVAL TOOL SET | 22Q3-ASDD1030

- Remove fasteners that secure door panels and trim pieces without damage to panel or trim

**5 925:-**

## LONG HANDLE BRUSH (NYLON BRISTLE) 22Q3-WBNY18

**5 225:-**



## HVLP SPRAY GUN (1.4 MM) | 22Q3-BLPK14HVLP

- Lightweight and well-balanced while delivering a quality, first-class automotive finish
- Designed for the automotive refinishing painter, spray gun applies primer, base and clear coat
- Lowest trigger pull among guns in it's class
- Unmatched spray pattern size and quality repair kits

**5 1200:-**

